

Temperature-Dependent Plasticity in Pressure Vessel

Introduction

This example demonstrates how to use temperature dependent materials within the Nonlinear Structural Materials Module. Material data such as Young's modulus, yield stress and strain hardening have strong temperature dependencies.

A large container holds pressurized hot water. Several pipes are attached to the pressure vessel. Those pipes can rapidly transfer cold water in case of an emergency cooling. The pressure vessel is made of carbon steel with an internal cladding of stainless steel. In case of a fast temperature transient, the differences in thermal expansion properties between the materials cause high stresses.

Model Definition

GEOMETRY

The pressure vessel has the shape of a closed cylinder. Four pipes are attached at two levels along its height. At each level, the pipes are equidistantly spaced around the container.

The pipes are welded into the vessel and the welding can be considered as a chamfer between those two parts. The structure, together with its key dimensions, is presented in [Figure 1](#).

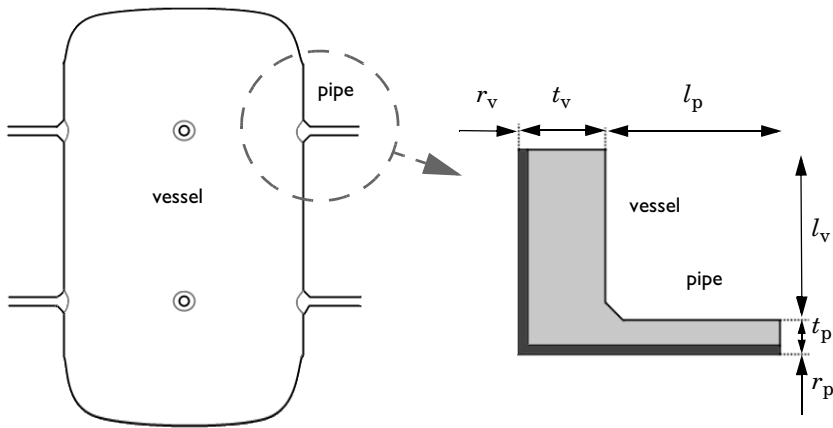

Figure 1: Pressure vessel and the dimensions for the vessel-pipe connection.

The structure has the following dimensions:

- Inner vessel radius, $r_v = 1000$ mm
- Inner pipe radius, $r_p = 60$ mm

- Vessel thickness, $t_v = 100$ mm
- Pipe thickness, $t_p = 40$ mm

The vessel length, l_v , and the pipe length, l_p , are large compared to the thickness of both parts. For modeling purposes, they need to be large enough so that local effects at the vessel-pipe connection can be disregarded. The chamfer extends 20 mm from the corner at the connection between the pipe and the vessel.

The dual material consists of a thin 10 mm layer of stainless steel (dark gray in [Figure 1](#)) that faces the water, and carbon steel (light gray in [Figure 1](#)) that faces the outside air.

In order to save computational time, only the connection between one pipe and the vessel is modeled, as shown on the left image of [Figure 1](#).

MATERIAL MODEL

The thermoelastic material data of stainless steel is given in [Table 1](#). [Table 2](#) shows the yield stress as a function of plastic strain at temperatures of 20, 100, 200, and 300°C.

TABLE 1: THERMOELASTIC MATERIAL DATA OF STAINLESS STEEL.

Temperature (°C)	20	100	200	300
E (GPa)	194	189	179	175
α (1/°C)	$16 \cdot 10^{-6}$	$16.5 \cdot 10^{-6}$	$17 \cdot 10^{-6}$	$17.5 \cdot 10^{-6}$
c_p (J/(kg·K))	482	498	515	524
k (W/(m·K))	13.9	14.9	17.0	18.0

TABLE 2: TEMPERATURE DEPENDENT YIELD STRESS OF STAINLESS STEEL.

Temperature (°C)	20	100	200	300
$\sigma_{ys}(0.0)$ (MPa)	228	190	156	140
$\sigma_{ys}(0.0004)$ (MPa)	232	195	160	144
$\sigma_{ys}(0.001)$ (MPa)	238	201	166	148
$\sigma_{ys}(0.002)$ (MPa)	246	210	173	155
$\sigma_{ys}(0.004)$ (MPa)	250	215	177	158
$\sigma_{ys}(0.001)$ (MPa)	263	230	189	169

The yield stress of the carbon steel is two or three times higher than that of stainless steel. It is therefore considered as elastic. Its material properties are shown in [Table 3](#).

TABLE 3: THERMOELASTIC MATERIAL DATA OF CARBON STEEL.

Temperature (°C)	20	100	200	300
E (GPa)	208	202	196	189
α (1/°C)	$10.9 \cdot 10^{-6}$	$12.4 \cdot 10^{-6}$	$13.8 \cdot 10^{-6}$	$14.9 \cdot 10^{-6}$
c_p (J/(kg·K))	489	519	546	569
k (W/(m·K))	51.2	48.3	45.5	42.7

The heat transfer coefficient between steel and air is $10 \text{ W}/(\text{m}^2 \cdot \text{K})$, and between steel and water it is $100 \text{ W}/(\text{m}^2 \cdot \text{K})$.

BOUNDARY CONDITIONS

A pressure of 70 bar acts on the inner walls of the vessel and the pipe. The temperature on the inside of the pressure vessel is initially at 280°C , while the outside air remains at 50°C . Suddenly and instantaneously, cold water at 20°C is pumped through the pipe into the vessel, where the hot water needs 30 minutes to cool down to 20°C . The cooling speed is constant.

MODEL ASSUMPTIONS

Due to symmetries, only a 45° sector of the vessel is modeled. The influence of the hot water pressure at the end of the vessel is approximated with an axial stress of 33.3 MPa , which is 4.76 times the inner pressure. The parameters l_v and l_p are both set to 200 mm.

Results and Discussion

Three studies are performed in this analysis. In an initial step, the mechanical and thermal stationary state is computed. This serves as initial conditions for a transient step which solves the heat transfer problem only, where the cold water flows through the pipe, cooling the initially hot water in the vessel. A comparison of the temperature profiles, before and after the event, are shown in [Figure 2](#). After 30 min, the water inside the vessel has cooled down to 20°C , but the container is still locally more than 100°C warmer. This leads to large gradients in the thermal strains.

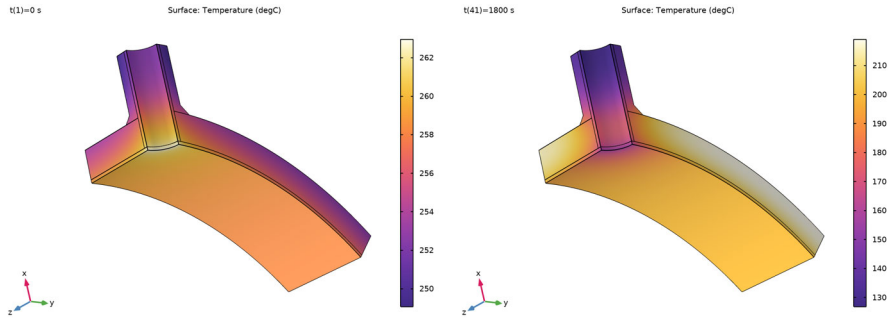

Figure 2: Temperature profiles before and after the cooling event.

The last step solves the elastoplastic deformation with temperature-dependent material parameters. The development of plastic strains in the stainless steel layer is shown in Figure 3. From the figure it can be seen that a plastic zone develops as the vessel cools down. Initially, when the vessel is at steady state, some plastic strains are generated by stresses caused by differences in the thermal expansion of the two steels. In a real structure, such stresses would have been relaxed after the first service cycle. In the transient study, when the vessel cools down and the yield limit increases, the pipe deforms plastically in other locations.

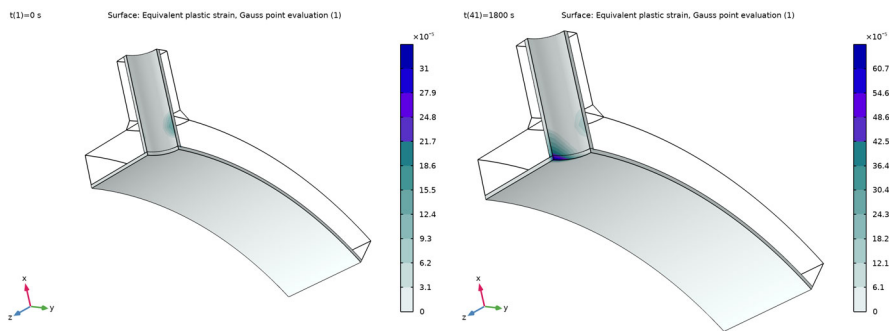

Figure 3: Plastic strains before and after the cooling event.

As the temperature decreases, the yield stress increases, so warm parts are more sensitive to high stresses. [Figure 4](#) shows the von Mises stress after 30 min of cooling.

t(41)=1800 s

Volume: von Mises stress, Gauss point evaluation (MPa)

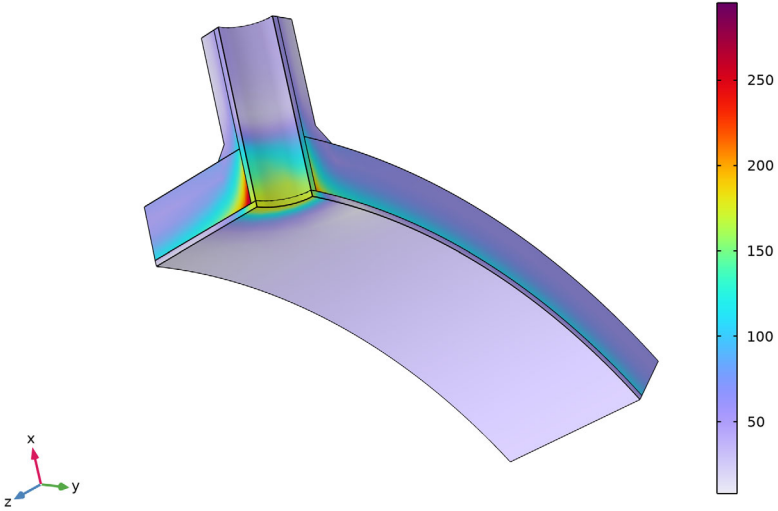

Figure 4: Distribution of von Mises stress after cooling down the hot water.

[Figure 5](#) shows the membrane plus bending stress intensity distribution during the cooling. It is clear that the location of the maximum intensity changes along the time. At the end of the cooling the maximum remains close to the nozzle.

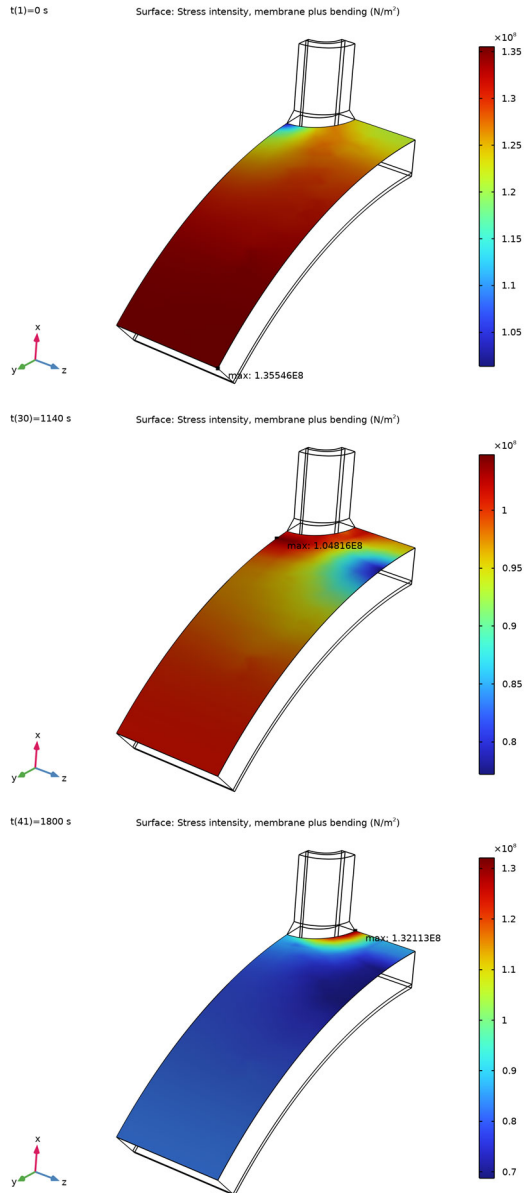

Figure 5: Membrane plus bending stress intensity at initial time (top), 1140 s (middle), and 1800 s (bottom).

Figure 6 shows the maximum of the membrane plus bending stress intensity variation during the cooling. One can notice that there is a minimum around 1140 s.

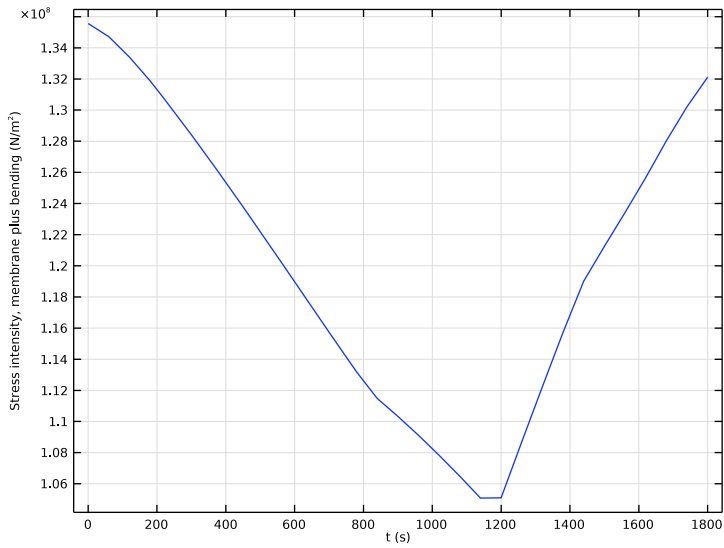

Figure 6: Maximum of membrane plus bending stress intensity with time.

Figure 7 shows the computed and linearized stress at initial time (solid) and once the cooling is done (dotted line).

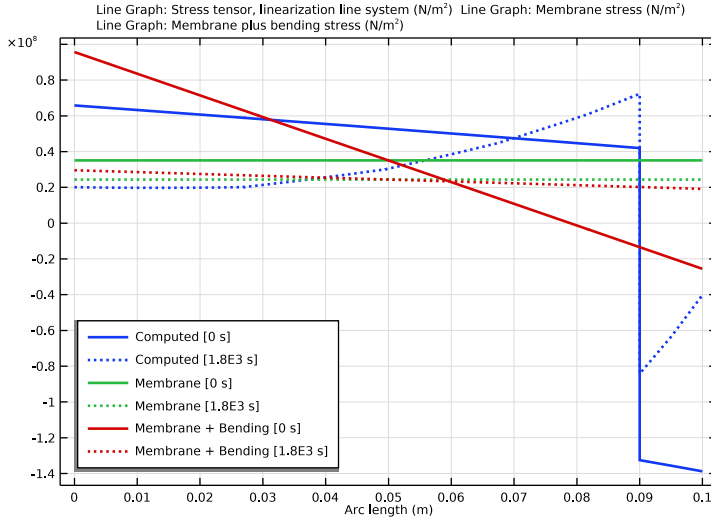

Figure 7: Computed stress (blue), Membrane stress (green), and Membrane plus bending stress (red) at initial time (solid line) and final time (dotted line).

Notes About the COMSOL Implementation

COMSOL Multiphysics can handle material data depending on several parameters. Use Interpolation functions, which you can select from the **Definitions** or **Materials** nodes. You can type in the data in a table or define your function in a text file. Use the symbol % in a text file to include comments or headers.

In this example, the Young’s modulus $E(T)$, coefficient of thermal expansion $\alpha(T)$, thermal conductivity $k(T)$, and heat capacity at constant pressure $C_p(T)$ are defined in the Materials node from interpolated data. The initial yield stress $\sigma_{y0}(T)$ and the nonlinear hardening function $\sigma_h(T, \epsilon_{pe})$ are defined by data imported from a text file.

Interpolation functions can handle any number of arguments. For convenience, specify units (Pa, m, s, and so on) for the function and arguments. When applicable, COMSOL Multiphysics automatically scales any input into the correct unit. For more details see the section *Operators, Functions, and Constants* in the *COMSOL Multiphysics Reference Manual*.

In this example there are two cuts that are “almost symmetry cuts” in the sense that they should stay plane but are still allowed to move in the normal direction. One is the cut in

the pipe, and the other is the cut through the pressure vessel wall. In order to accomplish this, a **Symmetry** node is used, but with free displacement as a normal direction condition. Thus the normal direction displacement is constant, but yet determined by the solution. The **Symmetry** node has different flavors of normal direction constraints, where the default is equivalent to a traditional symmetry condition.

Heat transfer in solids is a time-dependent phenomenon, and since plasticity is a path-dependent process, it is important to capture the evolution of temperature profiles accurately. You need to limit the time step in the BDF solver settings to account for the rate at which thermal loads change in time. Use a different study step to compute the elastoplastic deformation after computing the heat transfer. Since this is not a coupled problem, this segregated approach reduces computational time.

Application Library path: Nonlinear_Structural_Materials_Module/
Plasticity/temperature_dependent_plasticity



Modeling Instructions

From the **File** menu, choose **New**.

NEW

In the **New** window, click  **Model Wizard**.

MODEL WIZARD

- 1 In the **Model Wizard** window, click  **3D**.
- 2 In the **Select Physics** tree, select **Structural Mechanics>Thermal-Structure Interaction>Thermal Stress, Solid**.
- 3 Click **Add**.
- 4 Click  **Study**.
- 5 In the **Select Study** tree, select **General Studies>Stationary**.
- 6 Click  **Done**.

GLOBAL DEFINITIONS

Parameters 1



- 1 In the **Model Builder** window, under **Global Definitions** click **Parameters 1**.

- 2 In the **Settings** window for **Parameters**, locate the **Parameters** section.
- 3 In the table, enter the following settings:

Name	Expression	Value	Description
internalPressure	70[bar]	7E6 Pa	Internal pressure
t	0[s]	0 s	Time variable; used for stationary analysis

The thermal shock caused by the cold water is time dependent. Therefore the variable for time, t , needs to be set to zero so that the heat boundary conditions can be evaluated also in the static analysis.

GEOMETRY I

- 1 In the **Geometry** toolbar, click **Insert Sequence** and choose **Insert Sequence**.
- 2 Browse to the model's Application Libraries folder and double-click the file `temperature_dependent_plasticity_geom_sequence.mph`.
- 3 In the **Geometry** toolbar, click  **Build All**.
- 4 Click the  **Go to Default View** button in the **Graphics** toolbar.

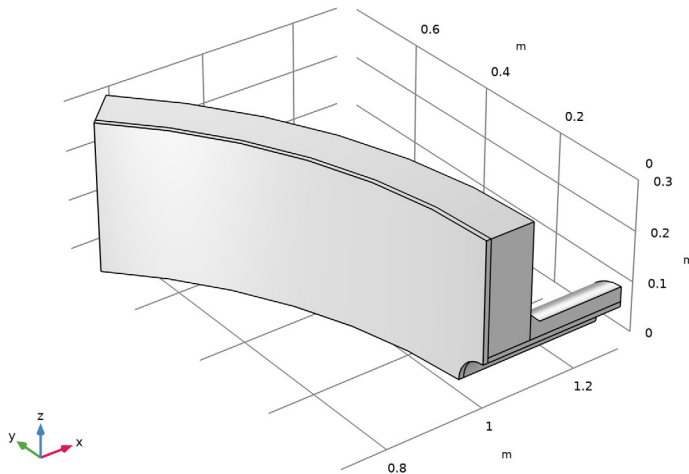

Full geometry instructions can be found in [Appendix — Geometry Modeling Instructions](#).

SOLID MECHANICS (SOLID)

Linear Elastic Material 1

In the **Model Builder** window, under **Component 1 (comp1)>Solid Mechanics (solid)** click **Linear Elastic Material 1**.

Plasticity 1

- 1 In the **Physics** toolbar, click  **Attributes** and choose **Plasticity**.
- 2 Select Domains 1 and 3 only.
- 3 In the **Settings** window for **Plasticity**, locate the **Plasticity Model** section.
- 4 Find the **Isotropic hardening model** subsection. From the list, choose **Hardening function**.

MATERIALS

Stainless Steel

- 1 In the **Model Builder** window, under **Component 1 (comp1)** right-click **Materials** and choose **Blank Material**.
- 2 In the **Settings** window for **Material**, type Stainless Steel in the **Label** text field.
- 3 Select Domains 1 and 3 only.
- 4 Locate the **Material Contents** section. In the table, enter the following settings:

Property	Variable	Value	Unit	Property group
Poisson's ratio	nu	0.3	1	Young's modulus and Poisson's ratio
Density	rho	8000	kg/m ³	Basic

Add Young's modulus as a function of temperature for the stainless steel.

Interpolation 1 (int1)

- 1 In the **Model Builder** window, expand the **Component 1 (comp1)>Materials>Stainless Steel (mat1)** node.
- 2 Right-click **Component 1 (comp1)>Materials>Stainless Steel (mat1)>Young's modulus and Poisson's ratio (Enu)** and choose **Functions>Interpolation**.
- 3 In the **Settings** window for **Interpolation**, locate the **Definition** section.
- 4 In the **Function name** text field, type fE.

5 In the table, enter the following settings:

t	f(t)
20	194
100	189
200	179
300	175

6 Locate the **Units** section. In the **Argument** table, enter the following settings:



Argument	Unit
t	degC

7 In the **Function** table, enter the following settings:

Function	Unit
fE	GPa

Stainless Steel (mat1)

Add the temperature as a model input for the Young's modulus property.

- 1 In the **Model Builder** window, under **Component 1 (comp1)>Materials>Stainless Steel (mat1)** click **Young's modulus and Poisson's ratio (Enu)**.
- 2 In the **Settings** window for **Young's Modulus and Poisson's Ratio**, locate the **Model Inputs** section.
- 3 Click  **Select Quantity**.
- 4 In the **Physical Quantity** dialog box, type temperature in the text field.
- 5 Click  **Filter**.
- 6 In the tree, select **General>Temperature (K)**.
- 7 Click **OK**.
- 8 In the **Settings** window for **Young's Modulus and Poisson's Ratio**, locate the **Output Properties** section.
- 9 In the table, enter the following settings:

Property	Variable	Expression	Unit	Size
Young's modulus	E	fE(T)	Pa	1x1

Add the coefficient of thermal expansion as a function of temperature for the stainless steel.

Interpolation 1 (int1)

- 1 In the **Model Builder** window, under **Component 1 (comp1)>Materials>Stainless Steel (mat1)** right-click **Basic (def)** and choose **Functions>Interpolation**.
- 2 In the **Settings** window for **Interpolation**, locate the **Definition** section.
- 3 In the **Function name** text field, type fA.
- 4 In the table, enter the following settings:

t	f(t)
20	16e-6
100	16.5e-6
200	17e-6
300	17.5e-6

- 5 Locate the **Units** section. In the **Argument** table, enter the following settings:

Argument	Unit
t	degC

- 6 In the **Function** table, enter the following settings:

Function	Unit
fA	1/K

Add the thermal conductivity as a function of temperature for the stainless steel.

Interpolation 2 (int2)

- 1 Right-click **Basic (def)** and choose **Functions>Interpolation**.
- 2 In the **Settings** window for **Interpolation**, locate the **Definition** section.
- 3 In the **Function name** text field, type fK.
- 4 In the table, enter the following settings:

t	f(t)
20	13.9
100	15.5
200	16.8
300	17.8

5 Locate the **Units** section. In the **Argument** table, enter the following settings:

Argument	Unit
t	degC

6 In the **Function** table, enter the following settings:

Function	Unit
fK	W/(m*degC)

Add the heat capacity as a function of temperature for the stainless steel.

Interpolation 3 (int3)

1 Right-click **Basic (def)** and choose **Functions>Interpolation**.

2 In the **Settings** window for **Interpolation**, locate the **Definition** section.

3 In the **Function name** text field, type fCp.

4 In the table, enter the following settings:

t	f(t)
20	482
100	504
200	521
300	530

5 Locate the **Units** section. In the **Argument** table, enter the following settings:

Argument	Unit
t	degC

6 In the **Function** table, enter the following settings:

Function	Unit
fCp	J/(kg*degC)

Stainless Steel (mat1)

Add the temperature as a model input for the Basic properties.

1 In the **Model Builder** window, under **Component 1 (comp1)>Materials>Stainless Steel (mat1)** click **Basic (def)**.

2 In the **Settings** window for **Basic**, locate the **Model Inputs** section.

3 Click **+ Select Quantity**.

- 4 In the **Physical Quantity** dialog box, click  **Filter**.
- 5 In the tree, select **General>Temperature (K)**.
- 6 Click **OK**.
- 7 In the **Model Builder** window, click **Stainless Steel (mat 1)**.
- 8 In the **Settings** window for **Material**, locate the **Material Contents** section.
- 9 In the table, enter the following settings:

Property	Variable	Value	Unit	Property group
Thermal conductivity	k_iso ; kii = k_iso, kij = 0	fK(T)	W/(m·K)	Basic
Heat capacity at constant pressure	Cp	fCp(T)	J/(kg·K)	Basic
Coefficient of thermal expansion	alpha_iso ; alphaii = alpha_iso, alphaij = 0	fA(T)	1/K	Basic

- 10 Locate the **Material Properties** section. In the **Material properties** tree, select **Solid Mechanics>Elastoplastic Material>Elastoplastic Material Model**.
- 11 Click  **Add to Material**.

Load the table containing yield stress as function of plastic strain and temperature.

Interpolation 1 (int 1)

- 1 In the **Model Builder** window, under **Component 1 (comp 1)>Materials>Stainless Steel (mat 1)** right-click **Elastoplastic material model (ElastoplasticModel)** and choose **Functions>Interpolation**.
- 2 In the **Settings** window for **Interpolation**, locate the **Definition** section.
- 3 From the **Data source** list, choose **File**.
- 4 Click  **Browse**.
- 5 Browse to the model's Application Libraries folder and double-click the file `temperature_dependent_plasticity_function.txt`.
- 6 Find the **Functions** subsection. In the table, enter the following settings:

Function name	Position in file
sY	1

7 Locate the **Units** section. In the **Argument** table, enter the following settings:

Argument	Unit
Column 1	degC
Column 2	1





8 In the **Function** table, enter the following settings:

Function	Unit
sY	Pa

9 Locate the **Definition** section. Click  **Import**.

Stainless Steel (mat1)

Add the temperature and the equivalent plastic strain as model inputs for the Elastoplastic material model properties.

- 1 In the **Model Builder** window, under **Component 1 (comp1)>Materials>Stainless Steel (mat1)** click **Elastoplastic material model (ElastoplasticModel)**.
- 2 In the **Settings** window for **Elastoplastic Material Model**, locate the **Model Inputs** section.
- 3 Click  **Select Quantity**.
- 4 In the **Physical Quantity** dialog box, click  **Filter**.
- 5 In the tree, select **General>Temperature (K)**.
- 6 Click **OK**.
- 7 In the **Settings** window for **Elastoplastic Material Model**, locate the **Model Inputs** section.
- 8 Click  **Select Quantity**.
- 9 In the **Physical Quantity** dialog box, type plastic strain in the text field.
- 10 Click  **Filter**.
- 11 In the tree, select **Solid Mechanics>Equivalent plastic strain (1)**.
- 12 Click **OK**.
- 13 In the **Settings** window for **Elastoplastic Material Model**, locate the **Output Properties** section.

14 In the table, enter the following settings:

Property	Variable	Expression	Unit	Size
Initial yield stress	sigmags	$sY(T, 0)$	Pa	1x1
Hardening function	sigmagh	$sY(T, \epsilon_{pe}) - sY(T, 0)$	Pa	1x1

The hardening function is the stress increase from the initial yield stress. As the full stress-strain curve is given, subtract the stress at zero equivalent plastic strain.

Carbon Steel

- 1 In the **Model Builder** window, right-click **Materials** and choose **Blank Material**.
- 2 In the **Settings** window for **Material**, type Carbon Steel in the **Label** text field.
- 3 Select Domains 2 and 4 only.
- 4 Locate the **Material Contents** section. In the table, enter the following settings:

Property	Variable	Value	Unit	Property group
Poisson's ratio	nu	0.3	1	Young's modulus and Poisson's ratio
Density	rho	8000	kg/m ³	Basic

Add Young's modulus as function of temperature for the carbon steel.

Interpolation 1 (int1)

- 1 In the **Model Builder** window, expand the **Component 1 (comp1)>Materials>Carbon Steel (mat2)** node.
- 2 Right-click **Component 1 (comp1)>Materials>Carbon Steel (mat2)>Young's modulus and Poisson's ratio (Enu)** and choose **Functions>Interpolation**.
- 3 In the **Settings** window for **Interpolation**, locate the **Definition** section.
- 4 In the **Function name** text field, type fE.
- 5 In the table, enter the following settings:

t	f(t)
20	208
100	202
200	196
300	189

6 Locate the **Units** section. In the **Argument** table, enter the following settings:

Argument	Unit
t	degC

7 In the **Function** table, enter the following settings:

Function	Unit
fE	GPa

Add the temperature as a model input for the Young's modulus property.

Carbon Steel (mat2)

- 1 In the **Model Builder** window, under **Component 1 (comp1)>Materials>Carbon Steel (mat2)** click **Young's modulus and Poisson's ratio (Enu)**.
- 2 In the **Settings** window for **Young's Modulus and Poisson's Ratio**, locate the **Model Inputs** section.
- 3 Click **+ Select Quantity**.
- 4 In the **Physical Quantity** dialog box, type temperature in the text field.
- 5 Click **Filter**.
- 6 In the tree, select **General>Temperature (K)**.
- 7 Click **OK**.

Add the coefficient of thermal expansion as function of temperature for the carbon steel.

Interpolation 1 (int1)

- 1 In the **Model Builder** window, under **Component 1 (comp1)>Materials>Carbon Steel (mat2)** right-click **Basic (def)** and choose **Functions>Interpolation**.
- 2 In the **Settings** window for **Interpolation**, locate the **Definition** section.
- 3 In the **Function name** text field, type fA.
- 4 In the table, enter the following settings:

t	f(t)
20	10.9e-6
100	12.4e-6
200	13.8e-6
300	14.9e-6

5 Locate the **Units** section. In the **Argument** table, enter the following settings:

Argument	Unit
t	degC

6 In the **Function** table, enter the following settings:

Function	Unit
fA	1/K

Interpolation 2 (int2)

1 Right-click **Basic (def)** and choose **Functions>Interpolation**.

Add the thermal conductivity as function of temperature for the carbon steel.

2 In the **Settings** window for **Interpolation**, locate the **Definition** section.

3 In the **Function name** text field, type fK.

4 In the table, enter the following settings:

t	f(t)
20	51.2
100	48.3
200	45.5
300	42.7

5 Locate the **Units** section. In the **Argument** table, enter the following settings:

Argument	Unit
t	degC

6 In the **Function** table, enter the following settings:

Function	Unit
fK	W/(m*degC)

Add the heat capacity as function of temperature for the carbon steel.

Interpolation 3 (int3)

1 Right-click **Basic (def)** and choose **Functions>Interpolation**.

2 In the **Settings** window for **Interpolation**, locate the **Definition** section.

3 In the **Function name** text field, type fCp.

4 In the table, enter the following settings:

t	f(t)
20	489
100	519
200	546
300	569

5 Locate the **Units** section. In the **Argument** table, enter the following settings:

Argument	Unit
t	degC

6 In the **Function** table, enter the following settings:

Function	Unit
fCp	J / (kg*degC)

Carbon Steel (mat2)

Add the temperature as a model input for the Basic properties.

- 1 In the **Model Builder** window, under **Component 1 (comp1)>Materials>Carbon Steel (mat2)** click **Basic (def)**.
- 2 In the **Settings** window for **Basic**, locate the **Model Inputs** section.
- 3 Click **+ Select Quantity**.
- 4 In the **Physical Quantity** dialog box, click **OK**.
- 5 In the **Model Builder** window, click **Carbon Steel (mat2)**.
- 6 In the **Settings** window for **Material**, locate the **Material Contents** section.
- 7 In the table, enter the following settings:

Property	Variable	Value	Unit	Property group
Young's modulus	E	fE(T)	Pa	Young's modulus and Poisson's ratio
Thermal conductivity	k_iso ; kii = k_iso, kij = 0	fK(T)	W/(m·K)	Basic

Property	Variable	Value	Unit	Property group
Heat capacity at constant pressure	Cp	fCp(T)	J/(kg·K)	Basic
Coefficient of thermal expansion	alpha_iso ; alpha_ii = alpha_iso, alpha_ij = 0	fA(T)	1/K	Basic

DEFINITIONS

Add the time history for the temperature of the water in the pipe.

Step 1 (step1)

- 1 In the **Home** toolbar, click **f(∞) Functions** and choose **Local>Step**.
- 2 In the **Settings** window for **Step**, type pipeWaterTemp in the **Function name** text field.
- 3 Locate the **Parameters** section. In the **Location** text field, type 1[s].
- 4 In the **From** text field, type 280[degC].
- 5 In the **To** text field, type 20[degC].

Add the time history for the temperature of the water in the pressure vessel.

Interpolation 1 (int1)

- 1 In the **Home** toolbar, click **f(∞) Functions** and choose **Local>Interpolation**.
- 2 In the **Settings** window for **Interpolation**, locate the **Definition** section.
- 3 In the **Function name** text field, type vesselWaterTemp.
- 4 In the table, enter the following settings:

t	f(t)
0	280
1800	20

- 5 Locate the **Units** section. In the **Argument** table, enter the following settings:

Argument	Unit
t	s

- 6 In the **Function** table, enter the following settings:

Function	Unit
vesselWaterTemp	degC

Create an explicit selection to use in the symmetry boundary conditions.

Symmetry Boundaries

- 1 In the **Definitions** toolbar, click  **Explicit**.
- 2 In the **Settings** window for **Explicit**, type **Symmetry Boundaries** in the **Label** text field.
- 3 Locate the **Input Entities** section. From the **Geometric entity level** list, choose **Boundary**.
- 4 Select Boundaries 1, 3–5, 7, 8, 11, 13, 16, 17, 19, and 22 only.

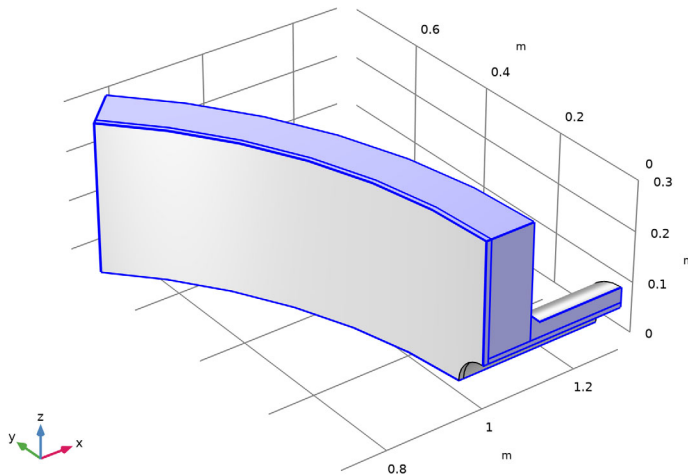

HEAT TRANSFER IN SOLIDS (HT)

Initial Values I

- 1 In the **Model Builder** window, under **Component 1 (comp1)>Heat Transfer in Solids (ht)** click **Initial Values I**.
- 2 In the **Settings** window for **Initial Values**, locate the **Initial Values** section.
- 3 In the T text field, type $280[\text{degC}]$.

Symmetry I

- 1 In the **Physics** toolbar, click  **Boundaries** and choose **Symmetry**.
- 2 In the **Settings** window for **Symmetry**, locate the **Boundary Selection** section.
- 3 From the **Selection** list, choose **Symmetry Boundaries**.

Heat Flux I

- 1 In the **Physics** toolbar, click  **Boundaries** and choose **Heat Flux**.

- 2 Select Boundaries 9, 20, and 23 only.
- 3 In the **Settings** window for **Heat Flux**, locate the **Heat Flux** section.
- 4 From the **Flux type** list, choose **Convective heat flux**.
- 5 In the h text field, type 10.
- 6 In the T_{ext} text field, type 50[degC].

Heat Flux 2

- 1 In the **Physics** toolbar, click  **Boundaries** and choose **Heat Flux**.
- 2 Select Boundaries 10 and 15 only.
- 3 In the **Settings** window for **Heat Flux**, locate the **Heat Flux** section.
- 4 From the **Flux type** list, choose **Convective heat flux**.
- 5 In the h text field, type 100.
- 6 In the T_{ext} text field, type pipeWaterTemp(t).

Heat Flux 3

- 1 In the **Physics** toolbar, click  **Boundaries** and choose **Heat Flux**.
- 2 Select Boundary 2 only.
- 3 In the **Settings** window for **Heat Flux**, locate the **Heat Flux** section.
- 4 From the **Flux type** list, choose **Convective heat flux**.
- 5 In the h text field, type 100.
- 6 In the T_{ext} text field, type vesselWaterTemp(t).

SOLID MECHANICS (SOLID)

In the **Model Builder** window, under **Component 1 (comp1)** click **Solid Mechanics (solid)**.

Symmetry 1

- 1 In the **Physics** toolbar, click  **Boundaries** and choose **Symmetry**.
- 2 In the **Settings** window for **Symmetry**, locate the **Boundary Selection** section.
- 3 From the **Selection** list, choose **Symmetry Boundaries**.

You will overwrite the extra boundaries of the explicit selection with a another **Symmetry** node, but with free displacement as normal constraint.

Symmetry 2

- 1 In the **Physics** toolbar, click  **Boundaries** and choose **Symmetry**.
- 2 Select Boundaries 4 and 8 only.

- 3 In the **Settings** window for **Symmetry**, click to expand the **Normal Direction Condition** section.
- 4 From the list, choose **Free displacement**.

Symmetry 3

- 1 In the **Physics** toolbar, click  **Boundaries** and choose **Symmetry**.
- 2 Select Boundaries 24 and 25 only.
- 3 In the **Settings** window for **Symmetry**, locate the **Normal Direction Condition** section.
- 4 From the list, choose **Free displacement**.

Boundary Load 1

- 1 In the **Physics** toolbar, click  **Boundaries** and choose **Boundary Load**.
- 2 Select Boundaries 2, 10, and 15 only.
- 3 In the **Settings** window for **Boundary Load**, locate the **Force** section.
- 4 From the **Load type** list, choose **Pressure**.
- 5 In the p text field, type `internalPressure`.

Boundary Load 2

- 1 In the **Physics** toolbar, click  **Boundaries** and choose **Boundary Load**.
- 2 Select Boundaries 4 and 8 only.
- 3 In the **Settings** window for **Boundary Load**, locate the **Force** section.
- 4 Specify the \mathbf{F}_A vector as

0	x
0	y
<code>4.76*internalPressure</code>	z

You will now add a **Stress Linearization** node to compute the linearized stress in the vessel.

Stress Linearization 1

- 1 In the **Physics** toolbar, click  **Global** and choose **Stress Linearization**.
- 2 In the **Settings** window for **Stress Linearization**, locate the **Linearization** section.
- 3 From the **Type** list, choose **Distributed**.

Using the Distributed type, you can find the critical location. You can later on set the starting point of the stress linearization line.

- 4 Locate the **Boundary Selection** section. Click to select the **Activate Selection** toggle button.

- 5 Select Boundary 9 only.
- 6 Locate the **Domain Selection** section. Click to select the  **Activate Selection** toggle button.
- 7 Select Domains 1 and 2 only.

MESH 1

Free Quad 1

- 1 In the **Mesh** toolbar, click  **Boundary** and choose **Free Quad**.
- 2 Select Boundary 19 only.

Size 1

- 1 Right-click **Free Quad 1** and choose **Size**.
- 2 In the **Settings** window for **Size**, locate the **Element Size** section.
- 3 Click the **Custom** button.
- 4 Locate the **Element Size Parameters** section.
- 5 Select the **Maximum element size** check box. In the associated text field, type 0.015.

Swept 1

- 1 In the **Mesh** toolbar, click  **Swept**.
- 2 In the **Settings** window for **Swept**, locate the **Domain Selection** section.
- 3 From the **Geometric entity level** list, choose **Domain**.
- 4 Select Domain 4 only.

Distribution 1

Right-click **Swept 1** and choose **Distribution**.

Free Quad 2

- 1 In the **Mesh** toolbar, click  **Boundary** and choose **Free Quad**.
- 2 Select Boundary 9 only.

Size 1

- 1 Right-click **Free Quad 2** and choose **Size**.
- 2 In the **Settings** window for **Size**, locate the **Element Size** section.
- 3 Click the **Custom** button.
- 4 Locate the **Element Size Parameters** section.
- 5 Select the **Maximum element size** check box. In the associated text field, type 0.05.

Swept 2

- 1 In the **Mesh** toolbar, click  **Swept**.
- 2 In the **Settings** window for **Swept**, locate the **Domain Selection** section.
- 3 From the **Geometric entity level** list, choose **Domain**.
- 4 Select Domain 2 only.

Distribution 1

- 1 Right-click **Swept 2** and choose **Distribution**.
- 2 In the **Settings** window for **Distribution**, locate the **Distribution** section.
- 3 From the **Distribution type** list, choose **Predefined**.
- 4 In the **Element ratio** text field, type 3.
- 5 Select the **Reverse direction** check box.

Swept 3

- 1 In the **Mesh** toolbar, click  **Swept**.
- 2 In the **Settings** window for **Swept**, locate the **Domain Selection** section.
- 3 From the **Geometric entity level** list, choose **Domain**.
- 4 Select Domain 3 only.

Distribution 1

- 1 Right-click **Swept 3** and choose **Distribution**.
- 2 In the **Settings** window for **Distribution**, locate the **Distribution** section.
- 3 In the **Number of elements** text field, type 2.

Swept 4

In the **Mesh** toolbar, click  **Swept**.

Distribution 1

- 1 Right-click **Swept 4** and choose **Distribution**.
- 2 In the **Settings** window for **Distribution**, locate the **Distribution** section.
- 3 In the **Number of elements** text field, type 2.
- 4 Click  **Build Selected**.

STUDY 1: INITIALIZATION

- 1 In the **Model Builder** window, click **Study 1**.

- 2 In the **Settings** window for **Study**, type Study 1: Initialization in the **Label** text field.
In an initialization study, the mechanical and the thermal stationary state is computed. This serves as initial conditions for a transient step.
- 3 Locate the **Study Settings** section. Clear the **Generate default plots** check box.
- 4 In the **Home** toolbar, click  **Compute**.

ADD STUDY

- 1 In the **Home** toolbar, click  **Add Study** to open the **Add Study** window.
In a second study, the transient temperature distribution is computed.
- 2 Go to the **Add Study** window.
- 3 Find the **Studies** subsection. In the **Select Study** tree, select **General Studies> Time Dependent**.
- 4 Find the **Physics interfaces in study** subsection. In the table, clear the **Solve** check box for **Solid Mechanics (solid)**.
- 5 Click **Add Study** in the window toolbar.



STUDY 2

Step 1: Time Dependent

- 1 In the **Settings** window for **Time Dependent**, locate the **Study Settings** section.
- 2 In the **Output times** text field, type range (0,0.2,2) range (60,60,1800).
Analyze half an hour, storing the results once every minute. The first steps are refined in order to improve the convergence.
- 3 Click to expand the **Values of Dependent Variables** section. Find the **Initial values of variables solved for** subsection. From the **Settings** list, choose **User controlled**.
- 4 From the **Method** list, choose **Solution**.
- 5 From the **Study** list, choose **Study 1: Initialization, Stationary**.
- 6 Find the **Values of variables not solved for** subsection. From the **Settings** list, choose **User controlled**.
- 7 From the **Method** list, choose **Solution**.
- 8 From the **Study** list, choose **Study 1: Initialization, Stationary**.
- 9 In the **Model Builder** window, click **Study 2**.
- 10 In the **Settings** window for **Study**, type Study 2: Heat Transfer in the **Label** text field.

11 Locate the **Study Settings** section. Clear the **Generate default plots** check box.

Solution 2 (sol2)

- 1 In the **Study** toolbar, click  **Show Default Solver**.
- 2 In the **Model Builder** window, expand the **Solution 2 (sol2)** node, then click **Time-Dependent Solver 1**.
- 3 In the **Settings** window for **Time-Dependent Solver**, click to expand the **Time Stepping** section.
Since cold water is suddenly injected in the vessel, it is important to capture the development accurately, so you want to enforce intermediate steps.
- 4 From the **Steps taken by solver** list, choose **Intermediate**.
- 5 In the **Study** toolbar, click  **Compute**.

ADD STUDY

- 1 Go to the **Add Study** window.
- 2 Find the **Studies** subsection. In the **Select Study** tree, select **General Studies>Stationary**.
- 3 Find the **Physics interfaces in study** subsection. In the table, clear the **Solve** check box for **Heat Transfer in Solids (ht)**.
- 4 Click **Add Study** in the window toolbar.
In a third study, the elastoplastic problem is computed using a stationary continuation study step.
- 5 In the **Study** toolbar, click  **Add Study** to close the **Add Study** window.

STUDY 3

Step 1: Stationary



- 1 In the **Settings** window for **Stationary**, click to expand the **Values of Dependent Variables** section.
- 2 Find the **Initial values of variables solved for** subsection. From the **Settings** list, choose **User controlled**.
- 3 From the **Method** list, choose **Solution**.
- 4 From the **Study** list, choose **Study 1: Initialization, Stationary**.
- 5 Find the **Values of variables not solved for** subsection. From the **Settings** list, choose **User controlled**.
- 6 From the **Method** list, choose **Solution**.
- 7 From the **Study** list, choose **Study 2: Heat Transfer, Time Dependent**.

- 8 From the **Time (s)** list, choose **Automatic (all solutions)**.
- 9 Click to expand the **Study Extensions** section. Select the **Auxiliary sweep** check box.
- 10 Click  **Add**.
- 11 In the table, enter the following settings:

Parameter name	Parameter value list	Parameter unit
t (Time variable; used for stationary analysis)	range (0, 0.2, 2) range (60, 60, 1800)	s

- 12 In the **Model Builder** window, click **Study 3**.
- 13 In the **Settings** window for **Study**, type Study 3: Plasticity in the **Label** text field.

Solution 3 (sol3)

- 1 In the **Study** toolbar, click  **Show Default Solver**.
- 2 In the **Model Builder** window, expand the **Solution 3 (sol3)** node.
- 3 In the **Model Builder** window, expand the **Study 3: Plasticity>Solver Configurations>Solution 3 (sol3)>Stationary Solver 1** node, then click **Fully Coupled 1**.
- 4 In the **Settings** window for **Fully Coupled**, click to expand the **Method and Termination** section.
Use a double dogleg solver in order to improve the convergence.
- 5 From the **Nonlinear method** list, choose **Double dogleg**.
- 6 In the **Study** toolbar, click  **Compute**.

Add a predefined plot of the von Mises stress.



RESULTS

Volume 1

- 1 In the **Model Builder** window, expand the **Stress (solid)** node, then click **Volume 1**.
- 2 In the **Settings** window for **Volume**, locate the **Expression** section.
- 3 From the **Unit** list, choose **MPa**.

Deformation

- 1 In the **Model Builder** window, expand the **Volume 1** node, then click **Deformation**.
- 2 In the **Settings** window for **Deformation**, locate the **Scale** section.
- 3 Select the **Scale factor** check box. In the associated text field, type 0.



- 4 In the **Stress (solid)** toolbar, click  **Plot**.
Add a predefined plot of the Equivalent Plastic Strain.
- 5 In the **Home** toolbar, click  **Add Predefined Plot**.

ADD PREDEFINED PLOT

- 1 Go to the **Add Predefined Plot** window.
- 2 In the tree, select **Study 3: Plasticity/Solution 3 (sol3)>Solid Mechanics>Equivalent Plastic Strain (solid)**.
- 3 Click **Add Plot** in the window toolbar.
- 4 In the **Home** toolbar, click  **Add Predefined Plot**.

RESULTS

Equivalent Plastic Strain (solid)

- 1 In the **Model Builder** window, under **Results>Stress (solid)>Volume 1** click **Deformation**.
- 2 In the **Equivalent Plastic Strain (solid)** toolbar, click  **Plot**.
- 3 In the **Model Builder** window, click **Equivalent Plastic Strain (solid)**.
- 4 In the **Settings** window for **3D Plot Group**, locate the **Data** section.
- 5 From the **Parameter value (t (s))** list, choose **0**.
- 6 In the **Equivalent Plastic Strain (solid)** toolbar, click  **Plot**.
- 7 From the **Parameter value (t (s))** list, choose **1200**.
- 8 In the **Equivalent Plastic Strain (solid)** toolbar, click  **Plot**.

Add a plot of the temperature in the vessel.

Temperature (ht)

- In the **Model Builder** window, right-click **Results** and choose **Add Predefined Plot>Study 3: Plasticity/Solution 3 (sol3)>Heat Transfer in Solids>Temperature (ht)**.

Surface

- 1 In the **Model Builder** window, expand the **Temperature (ht)** node, then click **Surface**.
- 2 In the **Settings** window for **Surface**, locate the **Expression** section.
- 3 From the **Unit** list, choose **degC**.
- 4 In the **Temperature (ht)** toolbar, click  **Plot**.

Temperature (ht)

- 1 In the **Model Builder** window, click **Temperature (ht)**.

- 2 In the **Settings** window for **3D Plot Group**, locate the **Data** section.
- 3 From the **Parameter value (t (s))** list, choose **0**.
- 4 In the **Temperature (ht)** toolbar, click  **Plot**.

In the steps below you will investigate the bending and membrane stress in the vessel. First evaluate the maximum of the stress intensity for all time steps.

Stress Intensity, Maximum

- 1 In the **Results** toolbar, click  **Evaluation Group**.
- 2 In the **Settings** window for **Evaluation Group**, type Stress Intensity, Maximum in the **Label** text field.
- 3 Locate the **Data** section. From the **Dataset** list, choose **Study 3: Plasticity/ Solution 3 (sol3)**.

Surface Maximum 1

- 1 Right-click **Stress Intensity, Maximum** and choose **Maximum>Surface Maximum**.
- 2 Select Boundary 9 only.
- 3 In the **Settings** window for **Surface Maximum**, click **Replace Expression** in the upper-right corner of the **Expressions** section. From the menu, choose **Component 1 (comp1)> Solid Mechanics>Stress linearization>solid.Slmb - Stress intensity, membrane plus bending - N/m²**.
- 4 Click to expand the **Configuration** section. Select the **Include position** check box.
- 5 In the **Stress Intensity, Maximum** toolbar, click  **Evaluate**.

The evaluation of the stress intensity over the whole surface for all time steps can take few minutes.

TABLE

- 1 Go to the **Table** window.
- 2 Click **Table Graph** in the window toolbar.

RESULTS

Stress Intensity, Maximum

- 1 In the **Model Builder** window, under **Results** click **ID Plot Group 5**.
- 2 In the **Settings** window for **ID Plot Group**, type Stress Intensity, Maximum in the **Label** text field.

Table Graph 1

- 1 In the **Model Builder** window, click **Table Graph 1**.
- 2 In the **Settings** window for **Table Graph**, locate the **Data** section.
- 3 From the **Plot columns** list, choose **Manual**.
- 4 In the **Columns** list, select **Stress intensity, membrane plus bending (N/m²)**.
- 5 In the **Stress Intensity, Maximum** toolbar, click  **Plot**.

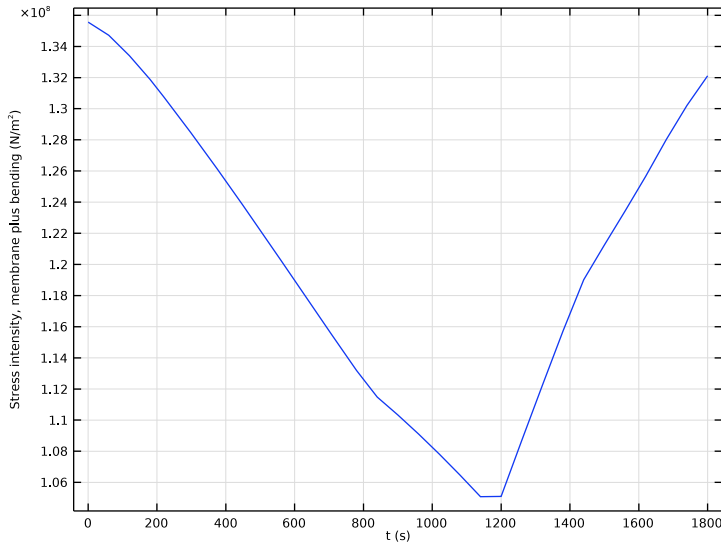

The plot shows that the maximum of stress intensity has a dip just before 1200 s. Look at the distribution of the stress intensity at different times: start, end, and at the dip.

Stress Intensity

- 1 In the **Home** toolbar, click  **Add Plot Group** and choose **3D Plot Group**.
- 2 In the **Settings** window for **3D Plot Group**, type **Stress Intensity** in the **Label** text field.
- 3 Locate the **Data** section. From the **Dataset** list, choose **Study 3: Plasticity/ Solution 3 (sol3)**.

Surface 1

Right-click **Stress Intensity** and choose **Surface**.

Selection 1

- 1 In the **Model Builder** window, right-click **Surface 1** and choose **Selection**.
- 2 Select **Boundary 9** only.



Surface 1

- 1 In the **Model Builder** window, click **Surface 1**.
- 2 In the **Settings** window for **Surface**, click **Replace Expression** in the upper-right corner of the **Expression** section. From the menu, choose **Component 1 (comp1)>Solid Mechanics>Stress linearization>solid.Slmb - Stress intensity, membrane plus bending - N/m²**.

Marker 1

- 1 Right-click **Surface 1** and choose **Marker**.
- 2 In the **Settings** window for **Marker**, locate the **Display** section.
- 3 From the **Display** list, choose **Max**.
- 4 In the **Stress Intensity** toolbar, click  **Plot**.

Stress Intensity

- 1 In the **Model Builder** window, under **Results** click **Stress Intensity**.
- 2 In the **Settings** window for **3D Plot Group**, locate the **Data** section.
- 3 From the **Parameter value (t (s))** list, choose **1140**.
- 4 In the **Stress Intensity** toolbar, click  **Plot**.
- 5 From the **Parameter value (t (s))** list, choose **0**.
- 6 In the **Stress Intensity** toolbar, click  **Plot**.

You will now plot the stress linearization line at the critical location.

Stress Linearization (solid)

- 1 In the **Model Builder** window, expand the **Results>Datasets** node, then click **Results>Stress Linearization (solid)**.
- 2 In the **Settings** window for **1D Plot Group**, locate the **Data** section.
- 3 From the **Time selection** list, choose **From list**.
- 4 In the **Parameter values (t (s))** list, choose **0** and **1800**.

Stress Tensor, Linearization Line System

- 1 In the **Model Builder** window, expand the **Stress Linearization (solid)** node, then click **Stress Tensor, Linearization Line System**.
- 2 In the **Settings** window for **Line Graph**, click to expand the **Coloring and Style** section.
- 3 From the **Width** list, choose **2**.
- 4 Click to expand the **Legends** section. In the **Legend** text field, type `Computed [eval(t s)]`.

Membrane Stress

- 1 In the **Model Builder** window, click **Membrane Stress**.
- 2 In the **Settings** window for **Line Graph**, locate the **Coloring and Style** section.
- 3 From the **Width** list, choose **2**.
- 4 Locate the **Legends** section. In the **Legend** text field, type Membrane [eval(t) s].

Membrane Plus Bending Stress

- 1 In the **Model Builder** window, click **Membrane Plus Bending Stress**.
- 2 In the **Settings** window for **Line Graph**, locate the **Coloring and Style** section.
- 3 From the **Width** list, choose **2**.
- 4 Locate the **Legends** section. In the **Legend** text field, type Membrane + Bending [eval(t) s].

SOLID MECHANICS (SOLID)

Stress Linearization I

- 1 In the **Model Builder** window, under **Component 1 (comp1)>Solid Mechanics (solid)** click **Stress Linearization I**.
- 2 In the **Settings** window for **Stress Linearization**, click to expand the **Postprocessing** section.

In the **Stress Intensity Maximum** evaluation group you can find the coordinates of the critical point.
- 3 Specify the **Linearization line, starting point** vector as

0.77782	X
0.77782	Y
0.295	Z

STUDY 3: PLASTICITY

Solution 3 (sol3)

- In the **Model Builder** window, under **Study 3: Plasticity>Solver Configurations** right-click **Solution 3 (sol3)** and choose **Solution>Update**.

RESULTS

Stress Linearization (solid)

- 1 In the **Settings** window for **ID Plot Group**, locate the **Legend** section.

- 2 From the **Position** list, choose **Lower left**.
- 3 In the **Stress Linearization (solid)** toolbar, click  **Plot**.



Appendix — Geometry Modeling Instructions

From the **File** menu, choose **New**.

NEW



In the **New** window, click  **Model Wizard**.

MODEL WIZARD



- 1 In the **Model Wizard** window, click  **3D**.
- 2 In the **Select Physics** tree, select **Structural Mechanics>Thermal-Structure Interaction>Thermal Stress, Solid**.
- 3 Click **Add**.
- 4 Click  **Study**.
- 5 In the **Select Study** tree, select **General Studies>Stationary**.
- 6 Click  **Done**.

GEOMETRY I



Work Plane 1 (wp1)

- 1 In the **Geometry** toolbar, click  **Work Plane**.
- 2 In the **Settings** window for **Work Plane**, locate the **Plane Definition** section.
- 3 From the **Plane** list, choose **xz-plane**.
- 4 Locate the **Unite Objects** section. Clear the **Unite objects** check box.
- 5 Click  **Show Work Plane**.

Work Plane 1 (wp1)>Polygon 1 (pol1)

- 1 In the **Work Plane** toolbar, click  **Polygon**.
- 2 In the **Settings** window for **Polygon**, locate the **Coordinates** section.
- 3 From the **Data source** list, choose **Vectors**.
- 4 In the **xw** text field, type 1.3 1.08 1.08 1.08 1.08 1.12 1.12 1.3 1.3 1.3.
- 5 In the **yw** text field, type 0.07 0.07 0.07 0.14 0.14 0.1 0.1 0.1 0.1 0.07.
- 6 Click  **Build Selected**.

Work Plane 1 (wp1)>Rectangle 1 (r1)

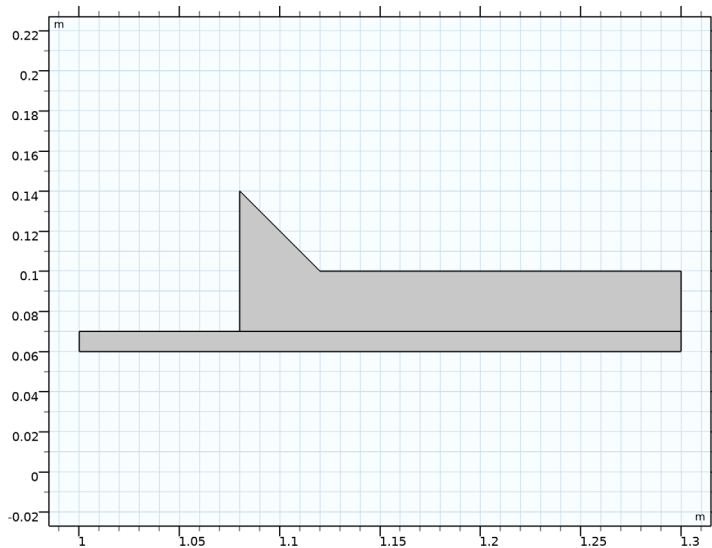

- 1 In the **Work Plane** toolbar, click  **Rectangle**.
- 2 In the **Settings** window for **Rectangle**, locate the **Size and Shape** section.
- 3 In the **Width** text field, type 0.3.
- 4 In the **Height** text field, type 0.01.
- 5 Locate the **Position** section. In the **xw** text field, type 1.
- 6 In the **yw** text field, type 0.06.
- 7 Click  **Build Selected**.





Revolve 1 (rev1)

- 1 In the **Model Builder** window, under **Component 1 (comp1)>Geometry 1** right-click **Work Plane 1 (wp1)** and choose **Revolve**.
- 2 In the **Settings** window for **Revolve**, locate the **Revolution Axis** section.
- 3 Find the **Direction of revolution axis** subsection. In the **xw** text field, type 1.
- 4 In the **yw** text field, type 0.
- 5 Locate the **Revolution Angles** section. Click the **Angles** button.
- 6 In the **End angle** text field, type -90.
- 7 Click  **Build Selected**.

Work Plane 2 (wp2)

- 1 In the **Geometry** toolbar, click  **Work Plane**.
- 2 In the **Settings** window for **Work Plane**, locate the **Plane Definition** section.
- 3 From the **Plane** list, choose **xz-plane**.
- 4 Locate the **Unite Objects** section. Clear the **Unite objects** check box.
- 5 Click  **Show Work Plane**.

Work Plane 2 (wp2)>Rectangle 1 (r1)

- 1 In the **Work Plane** toolbar, click  **Rectangle**.
- 2 In the **Settings** window for **Rectangle**, locate the **Size and Shape** section.
- 3 In the **Width** text field, type 0.09.
- 4 In the **Height** text field, type 0.3.
- 5 Locate the **Position** section. In the **xw** text field, type 1.01.
- 6 Click  **Build Selected**.



Work Plane 2 (wp2)>Rectangle 2 (r2)

- 1 In the **Work Plane** toolbar, click  **Rectangle**.
- 2 In the **Settings** window for **Rectangle**, locate the **Size and Shape** section.
- 3 In the **Width** text field, type 0.01.
- 4 In the **Height** text field, type 0.3.
- 5 Locate the **Position** section. In the **xw** text field, type 1.

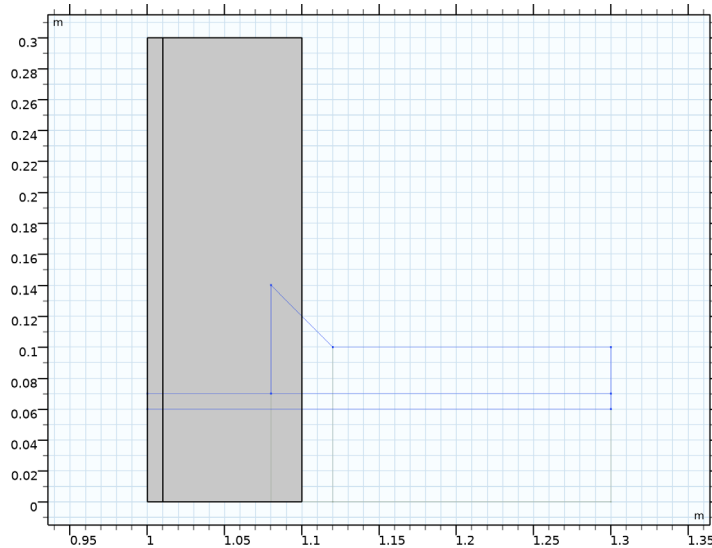

6 Click  **Build Selected.**



Revolve 2 (rev2)

- 1 In the **Model Builder** window, under **Component 1 (comp1)**>**Geometry 1** right-click **Work Plane 2 (wp2)** and choose **Revolve**.
- 2 In the **Settings** window for **Revolve**, locate the **Revolution Angles** section.
- 3 Click the **Angles** button.
- 4 In the **End angle** text field, type 45.
- 5 Click  **Build Selected.**
- 6 Click the  **Zoom Extents** button in the **Graphics** toolbar.

Difference 1 (dif1)

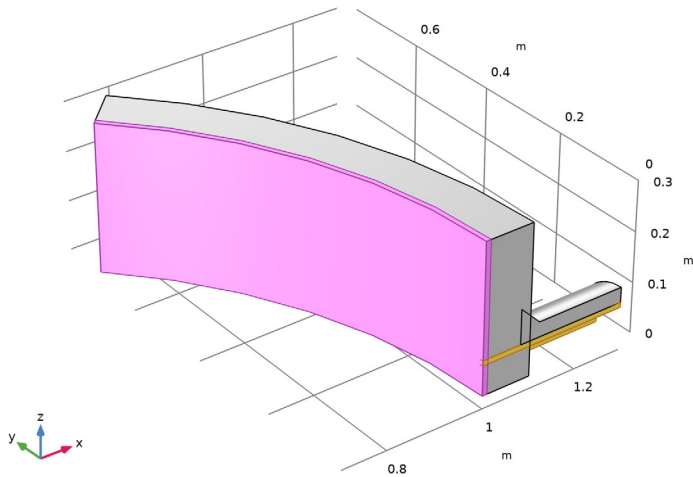

- 1 In the **Geometry** toolbar, click  **Booleans and Partitions** and choose **Difference**.
- 2 In the **Settings** window for **Difference**, locate the **Difference** section.
- 3 Select the **Keep objects to subtract** check box.
- 4 Clear the **Keep interior boundaries** check box.
- 5 Select the object **rev1(2)** only.
- 6 Find the **Objects to subtract** subsection. Click to select the  **Activate Selection** toggle button.

7 Select the object **rev2(2)** only.



8 Click  **Build Selected**.

Difference 2 (dif2)

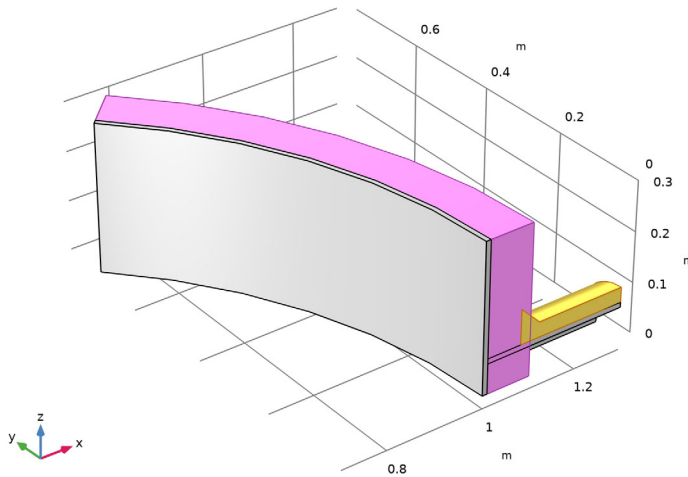

- 1 In the **Geometry** toolbar, click  **Booleans and Partitions** and choose **Difference**.
- 2 In the **Settings** window for **Difference**, locate the **Difference** section.
- 3 Select the **Keep objects to subtract** check box.
- 4 Select the object **rev1(1)** only.
- 5 Find the **Objects to subtract** subsection. Click to select the  **Activate Selection** toggle button.

6 Select the object **rev2(1)** only.





7 Click  **Build Selected**.

Cylinder 1 (cyl1)

- 1 In the **Geometry** toolbar, click  **Cylinder**.
- 2 In the **Settings** window for **Cylinder**, locate the **Size and Shape** section.
- 3 In the **Radius** text field, type 0.06.
- 4 In the **Height** text field, type 0.4.
- 5 Locate the **Position** section. In the **x** text field, type 0.95.
- 6 Locate the **Axis** section. From the **Axis type** list, choose **Cartesian**.
- 7 In the **x** text field, type 1.
- 8 In the **z** text field, type 0.
- 9 Click  **Build Selected**.

Difference 3 (dif3)

- 1 In the **Geometry** toolbar, click  **Booleans and Partitions** and choose **Difference**.
- 2 Select the objects **rev2(1)** and **rev2(2)** only.
- 3 In the **Settings** window for **Difference**, locate the **Difference** section.
- 4 Find the **Objects to subtract** subsection. Click to select the  **Activate Selection** toggle button.

5 Select the object **cyl1** only.

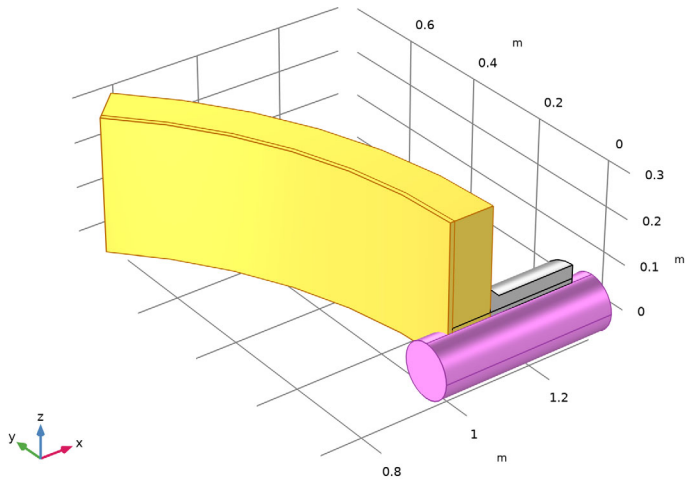

6 Click  **Build Selected**.

Difference 4 (dif4)

1 In the **Geometry** toolbar, click  **Booleans and Partitions** and choose **Difference**.

2 Select the object **dif3** only.

3 In the **Settings** window for **Difference**, locate the **Difference** section.

4 Find the **Objects to subtract** subsection. Click to select the  **Activate Selection** toggle button.

5 Select the object **dif1** only.

6 Select the **Keep objects to subtract** check box.

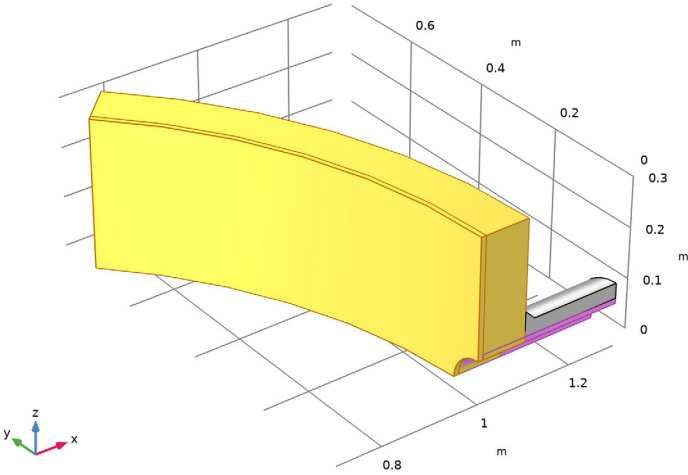

7 Click  **Build Selected.**

8 In the **Geometry** toolbar, click  **Build All.**

